

LEVEL METER FOR ANALOGUE AND DIGITAL TV MC-377

1 GENERAL

1.1 Description

The **MC-377** is a compact, light-weight, portable instrument which offers installers all the basic functions needed to guarantee the good operation of **analogue and digital TV** installations.

The instrument covers **television bands, hyperband, cable television S channels** as well as the **satellite** intermediate frequency band in K/C, up to 2050 MHz.

The **MC-377** has two main operation modes: **Monitor** mode and **Spectrum Analyser** mode:

The **Spectrum Analyser** mode enables all the signals present in a band to be viewed on the monitor. The bandwidth represented in the spectrum mode can be selected as either the complete band or a bandwidth defined by the user (from approximately 1/3 of the band in use to almost zero).

In the **Monitor** mode the instrument demodulates the analogue TV signal, which enables a terrestrial or satellite television channel to be identified and its reception observed. The signal level in monitor mode is represented by an analogue bar at the top of the image whose length varies in proportion to the power received. In addition it enables the line synchronism pulse to be observed, overlaid on the top centre of the screen.

The **MC-377** enables you to easily take the following measurements: **analogue signal levels, digital channel power** and **Carrier to Noise ratio (C/N)** in analogue and digital channels.

The instrument can also supply the voltage needed to power external units: aerial pre-amplifiers and LNBS with 13 or 18 V, together with a 22 kHz signal superimposed onto the voltage for the commutation of polarisation, band or signal switches.

1.2 Specifications

TUNING

VHF

LOW VHF band (VLO) from 48.25 to 168.25 MHz

HIGH VHF band (VHI) from 175.25 to 447.25 MHz

UHF

UHF band, from 455.25 to 855.25 MHz

SAT

Satellite IF band from 950 to 2050 MHz

Resolution

10 kHz in VHF and UHF

100 kHz in SAT

Frequency indication

By digital frequency counter

Display

LCD, 5 digits

RF INPUTS

TV and SAT

Impedance

75 Ω

Connector

BNC

Maximum signal

130 dB μ V

Maximum input voltage

DC to 100 Hz

50 V rms (powered by the mains supply)

30 V rms (not powered by the mains supply)

5 MHz to 2050 MHz

130 dB μ V

MEASUREMENTS

Types of measurements

Analogue signals level

Digital channels power

C/N ratio of analogue and digital signals

Terrestrial digital signals measurement

Calibrated for a channel bandwidth of 7.607 MHz

Satellite digital signals measurement

Calibrated for a *Symbol Rate* of 27.500 MBauds

Sensibility

TV bands

From 20 dB μ V to 130 dB μ V analogue signals

From 35 dB μ V to 125 dB μ V digital signals

Satellite band

From 40 dB μ V to 100 dB μ V analogue signals

From 45 dB μ V to 95 dB μ V digital signals

Reading

Scale calibrated in dB μ V (linear) for analogue signals level measurement.

Scale calibrated in dB μ V (linear) for digital channels power measurement.

Scale calibrated in dB (linear) for C/N ratio measurement of analogue and digital signals.

| | |
|-----------------------|--|
| Scales range | 60 dB for TV analogue signals 45 dB for TV digital signals 40 dB for SAT analogue signals 30 dB for TV digital signals 60 dB for C/N measurement |
| IF bandwidth | 250 kHz (TV) and 18 MHz (SAT) |
| RF attenuators | TV bands: 50 dB in 10 and 20 dB steps Satellite band: 20 dB |

Total accuracy (25 °C ± 5 °C)

| | |
|-----------------------|--------|
| TV bands | ± 4 dB |
| Satellite band | ± 6 dB |

When carrying out level and power measurements it is necessary to apply the correction chart which is delivered with the instrument.

| | |
|----------------------------------|---|
| Level acoustic indication | Tone whose frequency varies with the received signal level. |
|----------------------------------|---|

SPURIOUS SIGNALS
LOW VHF (VLO)

| | |
|-------------------------|--|
| Analogue signals | < 20 dB μ V (input 65 dB μ V not attenuated) |
| Digital signals | < 35 dB μ V (input 75 dB μ V not attenuated) |

HIGH VHF (VHI)

| | |
|-------------------------|--|
| Analogue signals | < 20 dB μ V (input 75 dB μ V not attenuated) |
| Digital signals | < 35 dB μ V (input 75 dB μ V not attenuated) |

UHF

| | |
|-------------------------|--|
| Analogue signals | < 20 dB μ V (input 75 dB μ V not attenuated) |
| Digital signals | < 35 dB μ V (input 75 dB μ V not attenuated) |

SAT

| | |
|-------------------------|--|
| Analogue signals | < 40 dB μ V (input 75 dB μ V not attenuated) |
| Digital signals | < 45 dB μ V (input 75 dB μ V not attenuated) |

MONITOR

| | |
|-------------------------|---|
| Monitor controls | B&W CRT 4,5" Brightness and contrast |
| Monitor mode | TV analogue signals demodulation |
| TV standard | Multistandard B, G, H and /L according to CCIR standards Multistandard M, N/L according to CCIR standards Multinorm D, K/L according to CCIR standards Multinorm I/L according to CCIR standards |
| Sensibility | > 40 dB μ V for correct synchronism in TV bands |

Spectrum Analyser Mode**Bandwidth****MAX mode**

Spectrum of the entire selected band, with a marker on the tuned frequency.

SPAN mode

Frequency spectrum representation around the tuned frequency, with variable bandwidth from 1/3 of the band (approximately) to almost zero.

SOUND

Analogue channels

Demodulation**TV**

Mono

TER

According to CCIR standard or manual tuning between 4.5 and 6,5 MHz except in the L standard and version MC-377/1.

SAT

Tuning between 5 and 8 MHz

Level indication

Tone whose frequency varies according to signal level

Output power

0.2 W

Volume control**Built-in speaker****EXT. UNITS POWER SUPPLY**

0/13/18V, 350 mA. Indicator of consumption higher than 50 mA and protections against short circuits and 50 VAC.

22 kHz signal

Selectable ON/OFF

Voltage

0.6 V \pm 0.2 V

Frequency

22 kHz \pm 4 kHz

POWER SUPPLY**Battery****Voltage**

12 V-2.6 Ah

Autonomy

>1 hour without external units powering (at 30% on/off).

40 minutes approximately with external units powering (at 30% on/off).

Recharging time

8 h approximately (starting from a total discharge)

Protections

Low battery indication (blinking colon on the display).

Minimum charge automatic cut-off.

Mains supply**Voltage**

110-125-220-230/240 V AC with voltage selector

Frequency

50-60 Hz

Consumption

55 W

OPERATING ENVIRONMENTAL CONDITIONS

| | |
|-------------------------------|---|
| Altitude | Up to 2000 m |
| Temperature margin | From 5 °C to 40 °C |
| Max. relative humidity | 80% (up to 31 °C), decreasing lineally up to 50% at 40 °C. |

MECHANICAL FEATURES

| | |
|-------------------|---|
| Dimensions | W. 280 x H. 95 x D. 250 mm (without carrying bag) |
| Weight | 5.2 kg (battery included) |

INCLUDED ACCESSORIES

| Model | Description |
|--------------|--|
| AD-050 | BNC/m-ANT/f adapter |
| AD-051 | BNC/m -F/f adapter |
| DC-236 | Carrying bag |
| CA-005 | Power cord |
| CB-041 | Rechargeable battery Pb 12 V / 2.6 Ah Fuse 3.15 A - T - 250 V IEC 127 |

OPTIONAL ACCESSORIES

| Model | Description |
|--------------|---------------------------------|
| AMC/1 | Reference antenna |
| AD-052 | BNC/m-TV/f (NF) adapter |
| AT-20 | 20 dB attenuator |
| CV-550 | 5-50 MHz converter |
| LN-370B | Low noise amplifier |
| MC-75/300 | 75 Ω (BNC) / 300 Ω (TV) adapter |
| NG-282 | Noise generator |

OPTIONS

| | |
|------------|--|
| OPT-377/10 | Level and power measuring scales in dBmV |
| OPT-377/63 | Satellite band extension up to 2100 MHz |

VERSIONS

| | |
|----------|--|
| MC-377/1 | Multinorm M, N/L according to CCIR standards |
| MC-377/2 | Multinorm D, K/L according to CCIR standards |
| MC-377/4 | Multinorm I/L according to CCIR standards |



2 SAFETY RULES













2.1 General

- * Use this equipment connected **only to devices or systems with their negative of measurement connected to ground potential.**
- * This is a **class I** equipment, for safety reasons plug it to a supply line with the corresponding **ground terminal.**
- * This equipment can be used in **Overvoltage Category II** installations and **Pollution Degree 2** environments.
- * When using some of the following accessories **use only the specified ones** to ensure safety:
 - Rechargeable battery
 - Power cord
- * Observe all **specified ratings** both of supply and measurement.
- * Remember that voltages higher than 60 V DC or 30 V AC rms are dangerous.
- * Use this instrument under the **specified environmental conditions.**
- * **The user is only authorized to** carry out the following maintenance operations:
 - Replace the battery.
 - Replace the mains fuse of the specified type and value.

On the Maintenance paragraph the proper instructions are given.

Any other change on the equipment should be carried out by qualified personnel.
- * The negative of measurement is at ground potential.
- * **Do not obstruct the ventilation system**
- * Follow the **cleaning instructions** described in the Maintenance paragraph

* Symbols related with safety:

| | |
|---|--|
|  | DIRECT CURRENT |
|  | ALTERNATING CURRENT |
|  | DIRECT AND ALTERNATING |
|  | GROUND TERMINAL |
|  | PROTECTIVE CONDUCTOR |
|  | FRAME TERMINAL |
|  | EQUIPOTENTIALITY |
|  | ON (Supply) |
|  | OFF (Supply) |
|  | DOUBLE INSULATION (Class II protection) |
|  | CAUTION (Risk of electric shock) |
|  | CAUTION REFER TO MANUAL |
|  | FUSE |

2.2 Specific precautions

When using the equipment powered by the mains supply it is suitable to be out of its carrying case.

3 INSTALLATION

The **MC-377** level meter is designed for use as a portable device. A carrying case is supplied to simplify transport and to allow the user to take measurements conveniently during the installation of the antenna.

3.1 Operating on the electrical mains supply

Although the device was designed for use as portable equipment, it can also operate when connected to the mains power supply. Connect the device to the mains and press the start switch **I/O** [3]. The level meter is now in operation and the battery will recharge slowly.

3.1.1 Selecting the mains operating voltage

This equipment requires a mains power source of 110-125-220 or 230/240 V AC 50 to 60 Hz. Mains operating voltage can be selected at the mains base.

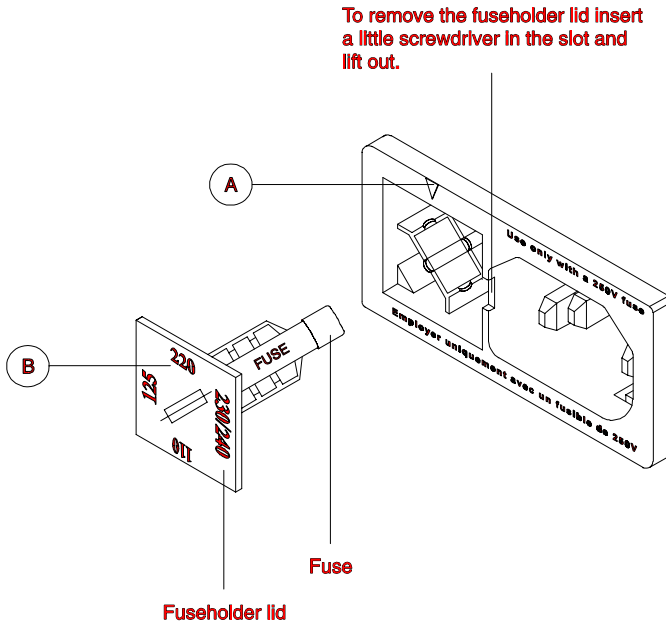

Figure 1.- Selection of mains voltage.

- 1.- Pull out the fuseholder lid.
- 2.- Insert the fuseholder lid so the [A] pointer faces the desired mains voltage display [B].

CAUTION

THE EQUIPMENT IS FACTORY SET FOR 220 V OPERATING VOLTAGE. BEFORE SWITCHING ON THIS INSTRUMENT, SET THE VOLTAGE SELECTOR TO THE PROPER POSITION AND BE SURE THAT THE FUSE VALUE IS ACCORDING TO THE MAINS VOLTAGE. AVOIDING THESE DIRECTIONS COULD DAMAGE THE EQUIPMENT.

3.2 Operating on the battery

The **MC-377** is a portable device powered by a 12 volt internal battery. Before taking any measurements, the battery charge must be checked. If the battery is low (a voltage lower than 11.2 V) colon sign (:) will appear blinking on the display of the frequency counter, under this circumstance the equipment must be connected to the mains to carry out the battery charge.

For the device to operate on the battery, disconnect the power cord and press the start switch **I/O** [3].

If the battery is very low, the cut-off circuit will prevent the device from functioning. In such a situation the battery must be recharged immediately.

3.2.1 Recharging the battery

The **MC-377** has an incorporated battery-charger which can be directly connected to the mains. Battery charging can take place during the normal working day. The instrument may still be used while the battery is being charged, under these conditions the battery will charge to up to 90% of its capacity.

To recharge the battery, connect the device to the mains supply **without** pressing the start switch **I/O** [3]. The length of time it takes to recharge depends on the condition of the battery. If it is very low (the low battery message appears) recharging period is 7-8 hours. The indicator light **LINE** [16] should remain lit.

IMPORTANT

The battery charge must always exceed the minimum cut-off charge.

To ensure the best results, the lead battery in this device must always be fully charged. If the equipment has been in storage or used only occasionally for a long period of time, it is ABSOLUTELY NECESSARY to check the full-charge functions periodically (every six months, for example), and to compensate for the self-discharging effect of the battery. The rate at which a fully charged battery self-discharges depends on the temperature. For example, at an ambient temperature of 20 °C, the battery suffers a 50% loss after 16 months and at 40 °C it loses the same charge in only 5 months (these are reference data). If the battery remains very low for a period of 4 weeks or more, it will not accept recharging since the plates are sulphated and must be replaced.



4 OPERATING INSTRUCTIONS

4.1 Description of the controls and elements

Front panel

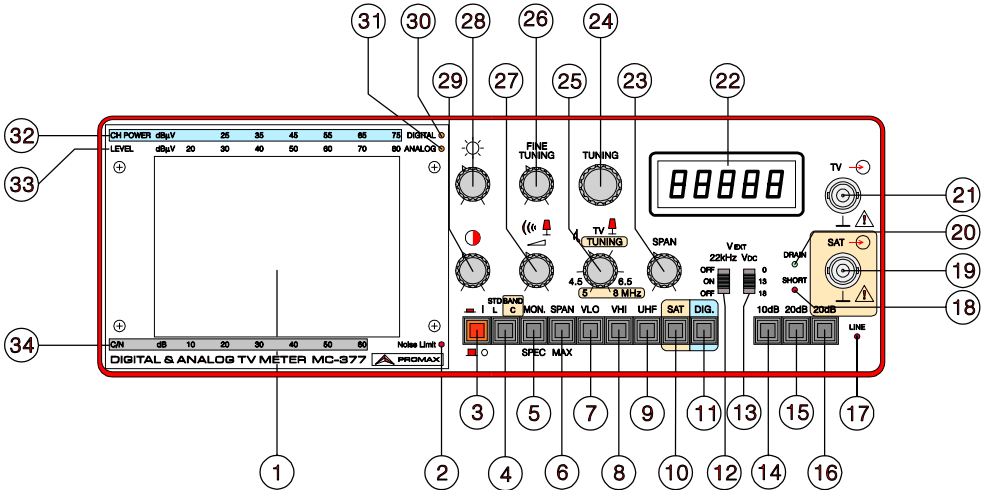

Figure 2.- Front panel.

- [1] **MONITOR**
- [2] **Noise Limit**
Luminous indicator showing detected noise level below meter noise level when measuring C/N.
- [3] **I/O** On / Off key.
- [4] **STD L / BAND C** Double function selector according on the active band.

In terrestrial bands.

Pressed key: it selects the "L" system.

Released key: it selects **B/G, I** and **D/K** systems.



In satellite band.

Pressed key: it selects the inverted video for the **C BAND**.

Released key: it selects the positive video for the **K BAND**.

- [5] **MON/SPEC** Operating mode selector:
Pressed key (**MON.**): **Monitor Mode**. The monitor [1] shows the demodulated TV signal corresponding to the tuned frequency.
Released key (**SPECT**): **Spectrum Analyser Mode**. The monitor [1] shows a frequency representation of the signal levels present in the band.
- [6] **SPAN/MAX** (Operational only in Spectrum Analyser mode)
Selects bandwidth represented in the Spectrum Analyser mode:
Pressed key (**SPAN** mode): Variable bandwidth, modified by the SPAN control [23].
Released key (**MAX** mode): Maximum bandwidth (shows the complete band).
- [7] **VLO** **LOW VHF** band selector.
- [8] **VHI** **HIGH VHF** band selector.
- [9] **UHF** **UHF** band selector.
- [10] **SAT** Satellite intermediate frequency selector.
- [11] **DIG** Digital channels measuring mode selector.
- [12] **22 kHz**
Activates the 22 kHz square signal superimposed onto the external unit supply voltage.
- [13] **V_{dc} 0/13/18 V** External units power supply selector.
- [14] **10 dB** Selects 10 dB attenuation in the terrestrial bands.
- [15] **20 dB** Selects 20 dB attenuation in the terrestrial bands.
- [16] **20 dB** Selects 10 dB attenuation in the terrestrial and satellite bands.
- When controls [14], [15] and [16] are selected simultaneously, the RF attenuation is 50 dB in terrestrial bands.*
- [17] **LINE**
Light indicator. Indicates whether the instrument is connected to the mains.
- [18] **SHORT**
Luminous indicator showing over-consumption by the external unit or short circuit.

- [19] **SAT** Satellite IF RF input and external unit powering (LNB) 0/13/18 V + 22 kHz.
- [20] **DRAIN** Luminous indicator showing the external unit normal consumption
- [21] **TV**
RF signal input in terrestrial bands and external unit powering (antenna previous amplifiers) (0/13/18 V ± 22 kHz).
- [22] **Digital frequency counter display**
Digital presentation of the tuned frequency in **MHz**. In the maximum bandwidth spectrum analyser operating mode (MAX) the digital frequency presentation is inhibited.
- [23] **SPAN**
(Operational only in the variable bandwidth Spectrum Analyser mode -SPAN-). Defines the frequency bandwidth to be shown.
- [24] **TUNING** Tuning control.
- [25] **TV / TUNING** Tuning control of the audio carrier:
Terrestrial bands:
 Pressed control: Sound corresponds to the internal filter according to CCIR standard.
 Released control: Variable tuning between **4.5 and 6.5 MHz** for the various TV standards, except standard **L** and in version **MC-377/1**, TV standard **M/N**.
Satellite band: Variable tuning between **5 and 8 MHz** irrespective of whether pressed or released.
- [26] **FINE TUNING** Fine tuning control.

- [27]  Audio control and activation of the measurement information over the image:
Pressed control: Selects television sound demodulation and permits the volume to be altered, also:
In Monitor mode it activates the measurement bar and the representation of the synchronism pulse.
In Spectrum Analyser mode, SPAN mode, it activates the C/N measurement bar.
Released control: Selects the acoustic signal to represent the level, the tone of which varies with the power received, and eliminates the measurement information from the monitor.
- [28]  CRT brightness control.
- [29]  CRT contrast control.
- [30] **DIGITAL** Digital channels measuring mode luminous indicator.
- [31] **ANALOG** Analogue channels measuring mode luminous indicator.
- [32] **CH POWER**
Measuring scale in dB μ V (or in dBmV for the OPT-377/10 option) for the measure of digital channels power.
- [33] **LEVEL**
Measuring scale in dB μ V (or in dBmV for the OPT-377/10 option) for the measure of analogue signals level.
- [34] Measuring scale in dB for the measure of the C/N ratio.

Lateral

- [35] Power supply input for voltages of 110-125-220-230/240 V, 50-60 Hz with voltage selector and fuse.

4.2 Using the level meter

4.2.1 Start-up



Press the **I/O** control [3]. The frequency counter display [22] will show the tuned frequency in MHz, except when the instrument is in **MAX** bandwidth spectrum analyser mode (**SPAN/MAX** key [6]).

4.2.2 Preliminary adjustments

Connect the aerial signal to one of the inputs, **TV** [21] or **SAT** [19], depending on the band you wish to analyse: VLO/VHI/UHF or SAT.

If necessary, power the external units (aerial pre-amplifiers or LNB) using switch **V_{DC}** [13] (0/13/18 V) and activate the 22 kHz commutation signal placing the **22 kHz** switch [12] in the ON position. When activating the external unit voltage supply, make sure that the **DRAIN** luminous indicator [20] remains lit and that the **SHORT** indicator [18] stays off.

Using the **MON./SPEC** key [5], select the **Monitor** or **Spectrum Analyser** mode. You are recommended to first select the complete band Spectrum Analyser mode (**SPAN/MAX** key [6] released) to view all the signals present on the band at the same time.

Adjust the brightness and contrast of the CRT screen with the  [28] and  [29] controls.

Select the desired frequency band with the **VLO** [7], **VHI** [8], **UHF** [9] and **SAT** [10] keys.

Tune to the desired frequency using the **TUNING** [24] and **FINE TUNING** [26] controls, the latter enables a more accurate tuning to be performed, especially in the UHF band. In the event of the frequency counter display [22] not showing anything, press the **SPAN/MAX** key [6] and adjust the represented bandwidth using the **SPAN** control [23].

If necessary, use the **10 dB** [14], **20 dB** [15] and **20 dB** keys [16] to select the appropriate attenuation.

Adjust the volume with the control  [27] or, if you wish, release the control in order to select the acoustic level signal, this will help you to search for the maximum signal level without having to continually watch the measurement screen.

4.2.3 Spectrum Analyser operating mode

The Spectrum Analyser operating mode enables you to be easily and quickly informed on the signals present in each band of the zone or region you are currently in. To select this operating mode, extract the **MON./SPEC** key [5] and an image will appear on the monitor similar to the one shown in the following figure.

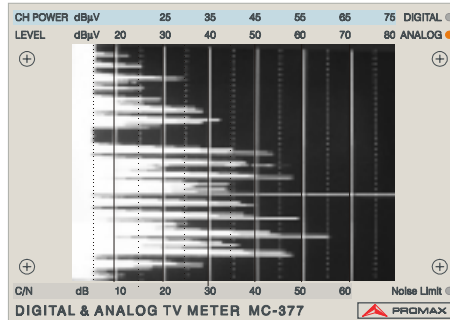

Figure 3.- Spectrum analyser mode, MAX mode.

The monitor will show a representation of the signals present in the band in function of each frequency. The vertical axis corresponds to the frequency, the higher frequencies being higher up on the screen and the lower ones further down. The horizontal axis represents the level of the signals present in the band, the amplitude of the lobes appearing on the screen represent the energy of the various signals present in the band.

The bandwidth shown can correspond to the entire selected band (**MAX** mode) with the **SPAN/MAX** key [6] released, or a smaller margin close to the current tuning frequency (**SPAN** mode) with the **SPAN/MAX** key [6] pressed, then acting on the **SPAN** control [23] in order to select the bandwidth to be shown, this may be chosen between approximately 1/3 of the band (depending on the width of each band, to maintain the power calibration) and a bandwidth of almost zero.

Having chosen a specific bandwidth, you may now vary the tuning with the **TUNING** control [24] to gradually sweep the entire band of selected frequencies. The frequency counter will show the tuned frequency.

In the complete band Spectrum Analyser mode (**MAX**, with the **SPAN/MAX** key [6] released) a white horizontal line will appear on the monitor (tuning mark) showing the tuning frequency (as can be seen in the previous figure). As you move across the frequencies with the **TUNING** control [24] you will see the mark move across the entire spectrum, allowing you to approximately pre-tune the frequency corresponding to the lobe that the mark is on.

IMPORTANT

IN THE MAX REPRESENTATION MODE, THE TUNING FREQUENCY READING ON THE FREQUENCY COUNTER DISPLAY [22] IS DEACTIVATED.

When obtaining the levels of different signals, you will find a set of continuous vertical lines on the image, together with others in the form of points, forming a grid which corresponds to divisions of 10 and 5 dB respectively, depending on the scales [32] or [33] found along the top of the monitor [1]. See section (4.2.5 Taking measurements).

In order to avoid saturation of the input stage, if you have several channels present at the input with amplitudes of about 75-80 dB μ V for analogue signals, or 70-75 dB μ V in the case of digital signals, you should use RF attenuators and thereby avoid the possibility of producing measurement errors.

One of the applications of the **MC-377** as a spectrum analyser is in searching for the best orientation and placement of receiver aerials, both for terrestrial TV and most particularly in the case of satellite TV.

In the satellite band (SAT), the device is also a great aid in the placement and correct orientation of aerials because it can detect a satellite signal even when the received signal is much weaker than the minimum level required to obtain an image. Furthermore, the instrument permits the exact adjustment of the LNB regarding its physical position to obtain the maximum ratio between Horizontal and Vertical polarities.

4.2.4 Monitor operating mode

In the Monitor operating mode the **MC-377** works like a conventional television. In addition, when the audio control  [27] is pressed, you will see a horizontal bar at the top of the image whose length corresponds to the level/power of the tuned signal. Below this bar, superimposed on the middle top of the TV image, the line synchronism pulse is shown with which it is possible to easily detect any possible saturation of the amplifiers in terrestrial bands. The following figure shows the three types of information appearing on-screen in the Monitor operating mode: demodulated television image (the example shown in figure 4 shows a scale of greys), measurement bar (67 dB μ V in figure 4) and a representation of the line synchronism.

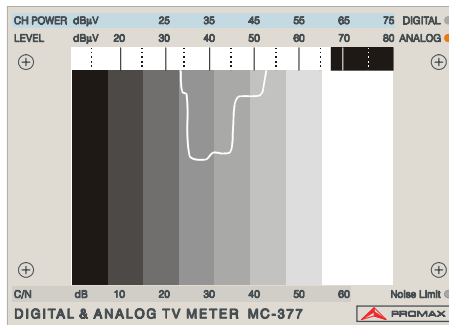



Figure 4.- Monitor operation mode.

To better observe and identify the tuned channel, it is possible to eliminate the measurement bar and the synchronism pulse by releasing the audio control  [27].

4.2.5 Taking measurements

The **MC-377** enables three different kinds of measurements to be taken:

Analogue signals level measurement

Digital channels power measurement

C/N ratio measurement of analogue and digital signals.

The following sections describe how to take each one of these measurements.

4.2.5.1 Measuring the level of analogue signals

To measure the level of an analogue signal, proceed as described below:

- Select the **Spectrum Analyser** operating mode, **SPAN** mode, and with the help of the frequency counter display [22] tune the signal using the **TUNING** [24] and **FINE TUNING** controls [26]. Adjust the **SPAN** control [23] to select a bandwidth so that the signal occupies the most part of the image. If you are dealing with a television signal it is also possible to take the measurement from the **Monitor** mode (in this case press the audio control [27] so that the measurement bar appears at the top of the image).
- Select the measurement scale for analogue signals **LEVEL** [33], in order to do this the **DIG** key [11] should be released and the **ANALOG** indicator [31] should remain lit.
- Read the level on the screen with the help of the scale calibrated in dB μ V (20-80 dB μ V) **LEVEL** [33]. If the level is very close to 80 dB μ V or is greater than this value, the signal should be attenuated using the RF attenuators.

On terrestrial bands the [14] **10 dB**, [15] **20 dB** and [16] **20 dB** attenuation keys must be pressed in order to obtain the signal level into the scale. The total attenuation is the addition of the keys pressed.

On the satellite band the [16] **20 dB** attenuation key must be pressed.

- The actual signal level is calculated in the following manner:

$$\text{Level [dB}\mu\text{V]} = \text{Reading [dB}\mu\text{V]} + \text{Attenuation [dB]} + \text{Correction Factor [dB]}$$

VERY IMPORTANT

THE CORRECTION FACTOR IS OBTAINED FROM THE CORRECTION CHART WHICH IS DELIVERED WITH THE INSTRUMENT. THIS VALUE DEPENDS ON THE FREQUENCY.

EXAMPLE A. Measuring the level of an analogue signal

Take the following figure as an example, showing a television channel: the lower part of the spectrum shows the lobe corresponding to the video carrier (**69 dBμV**) and in the upper part you can see the audio carrier (63 dBμV) preceded by the chrominance signal (40 dBμV). Note that the measurements are taken on the **LEVEL** scale [33].

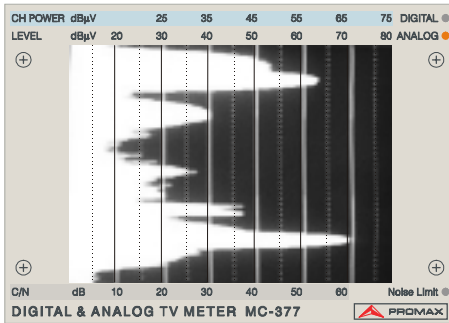

Measurement conditions:

Video carrier freq.: 551.25 MHz
RF attenuation: 10 dB
Mode: ANALOG

Figure 5.- Example of analogue signal level measurement.

We assume that the instrument was delivered with the following Correction Chart:

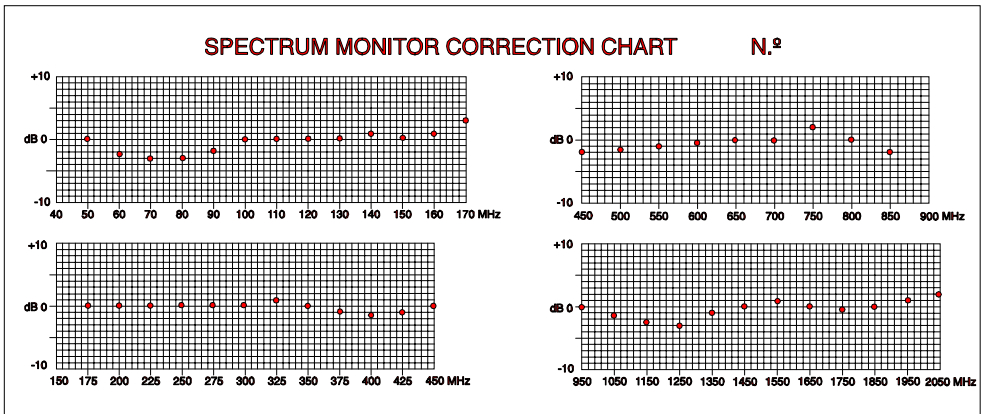

Figure 6.- Example of correction chart.

From the correction chart you find that the **Correction Factor** to be applied to the frequency you are working with (551.25 MHz) is **-1 dB**. Therefore, the actual signal level is:

$$\text{Level [dB}\mu\text{V]} = \text{Readout (69 dB}\mu\text{V)} + \text{Atten. (10 dB)} + \text{Correct. factor (-1 dB)} = \text{78 dB}\mu\text{V}$$

4.2.5.2 Measuring the power of digital channels

The main characteristic of digital signals is that they distribute their energy across the entire channel bandwidth (in the same way as a noise signal), in other words they do not possess a differentiated carrier. Given this different nature from analogue signals the method used for measuring can not be the same. You must use a detector appropriate for signals of a 'noisy nature' and take into consideration that the bandwidth of the measuring filter is smaller than the bandwidth of the channel.

The **MC-377** takes into account the properties of digital signals and enables the power of digital signals to be measured almost automatically, just follow the procedure below:

- Select the **Spectrum Analyser** operating mode, **SPAN** mode, and with the help of the frequency counter display [22] tune the signal using the **TUNING** [24] and **FINE TUNING** controls [26]. Adjust the **SPAN** control [23] to select a bandwidth so that the signal occupies the most part of the image.
- Select the digital signal measurement scale **CH POWER** [32], the **DIG** key [11] should be in the pressed position and the **DIGITAL** indicator [30] should remain lit.
- Read the level on the screen with the help of the scale calibrated in dB μ V (25-75 dB μ V) **CH POWER** [32]. If the level is very close to 75 dB μ V or is greater than this value, the signal should be attenuated using the RF attenuators.
- The actual signal level is calculated in the following manner:

$$\text{Power [dB}\mu\text{V]} = \text{Reading [dB}\mu\text{V]} + \text{Atten. [dB]} + \text{Correction Factor [dB]}$$

VERY IMPORTANT

THE CORRECTION FACTOR IS OBTAINED FROM THE CORRECTION CHART WHICH IS DELIVERED WITH THE INSTRUMENT. THIS VALUE DEPENDS ON THE FREQUENCY.

EXAMPLE B.- Measuring the power of a digital signal

Take the following figure as an example, showing a digital signal:

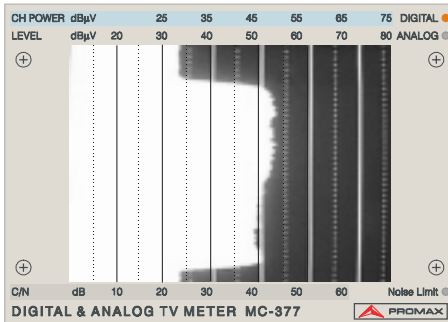

Measurement conditions:

Central frequency: 650.00 MHz
 RF attenuation: 0 dB
 Mode: DIGITAL

Figure 7.- Example of digital channel power measurement.

Using the **CH POWER** scale [32] (blue background) you can read a power of **45 dBµV**.

From the correction chart in figure 6, you obtain the **Correction Factor** to be applied to the frequency you are working with (650.00 MHz) which is **0 dB**. Therefore, the actual power of the channel is:

$$\text{Power [dBµV]} = \text{Reading (45 dBµV)} + \text{Atten. (0 dB)} + \text{Correct. Factor (0 dB)} = 45 \text{ dBµV}$$



To obtain further information on the digital signal measurement method refer to *Appendix A Digital TV signals*.

4.2.5.3 Measuring the C/N ratio of analogue and digital signals

Measuring the Carrier/Noise ratio provides us with information on the quality of analogue signals and the sturdiness of digital signals. The **Spectrum Analyser** operating mode, **SPAN** mode, enables this measurement to be made almost automatically.

To measure C/N, the **MC-377** measures the maximum level or power (depending on whether the analogue or digital measurement mode has been selected) present inside the represented bandwidth (defined by the **SPAN** control [23]) and subtracts the minimum noise level measured inside this bandwidth. Therefore, for the measurement to be correct it is essential that the maximum and minimum level signals appearing on the monitor are those for which you wish to evaluate the C/N ratio.

4.2.5.3.1 Measuring the C/N ratio of analogue channels

- Select the **Spectrum Analyser** operating mode, **SPAN** mode, and release the audio control  [27] so that the C/N measurement bar does not get in the way when choosing the right **SPAN**.
- Select the analogue signal measurement scale, **LEVEL** [33], the **DIG** key [11] should be released and the **ANALOG** indicator [31] should remain lit.
- Tune the signal using the **TUNING** [24] and **FINE TUNING** controls [26] with the help of the frequency counter display [22]. Turn the **SPAN** control [23] to select a bandwidth so that the maximum signal on the monitor is the video carrier and the minimum level signal is the noise. Remember that the noise can be measured, as you wish, either inside or outside the channel.
- Press the audio control  [27] to show the C/N measurement bar.
- Read the measurement on the monitor with the help of the scale calibrated in dB (10-60 dB) **C/N** [34]. If the signal level is close to 80 dB μ V or is greater than this value the signal should be attenuated using the RF attenuators.

If on taking the measurement the **Noise Limit** indicator [2] should light up, this means that the actual noise level is less than the noise level of the **MC-377** itself and, therefore, the instrument can not measure under these conditions. In this event it can be confirmed that the **actual measurement is better than the one obtained** (given that the actual noise is less). One way to avoid this situation is to amplify the signal, though then you will have to take into consideration the noise introduced by the amplifier.

EXAMPLE C.- Measuring the C/N ratio of an analogue signal

Take the following figure as an example, showing an analogue television signal:

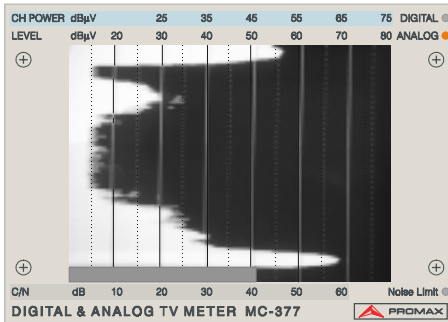

Measurement conditions:

Video carrier freq.: 520.25 MHz

RF attenuation: 10 dB

Mode: ANALOG

Noise Limit indicator ON

Figure 8.- Measuring the C/N ratio of an analogue channel.

In the example in the previous figure it has been decided to measure the C/N ratio inside the channel, in other words the noise is measured inside the channel at the point where the content of the video signal is the minimum.

From the **C/N** scale [34] you obtain a C/N ratio of **41 dB**.

Given that the **Noise Limit** indicator [2] was lit when the measurement was taken, we may come to the conclusion that the **C/N ratio is greater than 41 dB**.

4.2.5.3.2 Measuring the C/N ratio of digital channels

The C/N ratio of digital channels is measured in a similar way to analogue signals, but remember that for the instrument to interpret the signal as being digital you should select the digital signal measurement mode: simply, the **DIG** key [11] should be in the pressed position and the **DIGITAL** indicator [30] should remain lit.

EXAMPLE D.- Measuring the C/N ratio of a digital channel

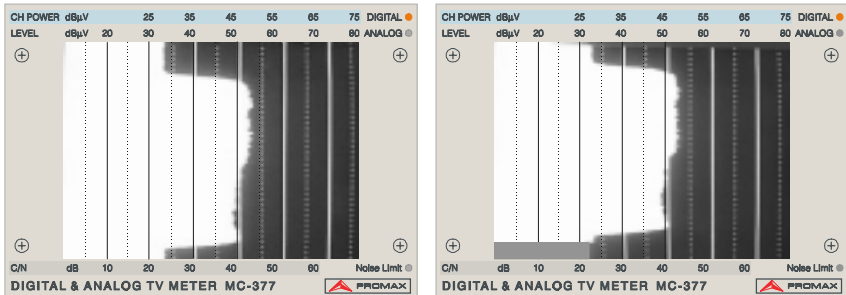

Audio control  [27] released.

Audio control  [27] pressed.

Measurement conditions:

Frequency : **650.00 MHz**
 RF attenuation: **0 dB**
 Noise limit indicator **ON**

Figure 9.- Measuring the C/N ratio of a digital channel.

The previous figure shows the image appearing on the monitor when the audio control  [27] is released (left) and when it is pressed (right, showing the C/N measurement bar). You are advised to adjust the **SPAN** control [23] so that there is no C/N measurement bar, as this may mask a signal from a lower adjacent channel and spoil the measurement.

From the **C/N** scale [34] (grey background) you obtain a C/N ratio of **21 dB**.

Given that the **Noise Limit** indicator [2] was lit when the measurement was taken, we may come to the conclusion that the **C/N ratio is greater than 21 dB**.



5 MAINTENANCE

5.1 Operating recommendations

One of the more common causes of breakdowns in TV signal level meters is the generation of internal short-circuits due to the introduction of small conductors. These conductors tend to be coaxial cable shielding wire, you are therefore advised **TO NOT CUT COAXIAL CABLES OVER THE INSTRUMENT.**

5.2 Fuses replacement

5.2.1 Mains fuse replacement

The fuseholder lid is placed in the mains base and it is the voltage selector. See figure 1 Selection of mains voltage, paragraph 3.1.1 *Selecting the mains operating voltage.*

To substitute the fuse, disconnect the power cord.

With an appropriate screw driver remove the fuseholder lid.

Substitute the melt fuse for another with following characteristics:

IMPORTANT

FUSE TYPE SHOULD BE 5 x 20 mm AND:

| | | | |
|---------------|----------|--------------|---------------------------|
| 2 A | T | 250 V | FOR 220, 230/240 V |
| 3.15 A | T | 250 V | FOR 110 AND 125 V |

AVOIDING THESE DIRECTIONS COULD DAMAGE THE EQUIPMENT

When inserting the fuseholder lid be careful that the voltage selector is in the correct position according to the mains.

5.2.2 Internal fuses which user cannot replace

The following fuse is found on the base board. Its location identification and characteristics are the following:

F1, 5 A F 63 V SMD

5.3 Battery replacement

The battery should be replaced when you notice that its capacity, once it has been charged, has decreased considerably (its mean life is of some 4 years). To change the battery follow next procedure.

With the instrument **off and disconnected from the mains**:

- Remove the securing screws from the upper and lower covers (6 screws on each cover). Remove the 2 covers.
- Disconnect the battery connection terminals.
- Place the instrument face down so you can see the underside of the base board. Remove the screw securing the battery holder to the base board, this screw is found located on the base board next to the rear panel of the instrument.
- Remove the screws securing the battery holder to the rear panel of the instrument (4 screws and their respective washers and grover washers). The battery holder will now be freed.
- Take out the battery together with the holder antiacid protector. Place the antiacid protector on the new battery and insert it into the holder. Take the utmost care to not invert the polarity when putting in place.
- Secure the battery holder to the rear panel (4 screws and their respective washers and grover washers).
- Secure the battery to the base board using the screw and serrated washer.
- Reconnect the battery: red cable to the positive terminal (+), black cable to the negative terminal (-).
- Finally, secure the upper and lower covers with the respective screws and washers.

VERY IMPORTANT

AVOID ANY TYPE OF SHORT CIRCUIT AMONG THE CABLES CONNECTED TO THE BATTERY, SINCE THE RESULTING HIGH CURRENT MAY CAUSE SERIOUS DAMAGE TO THE EQUIPMENT.

5.4 Cleaning recommendations

CAUTION

TO CLEAN THE COVER, TAKE CARE THE INSTRUMENT IS DISCONNECTED.

CAUTION

DO NOT USE SCENTED HYDROCARBONS OR CHLORIZED SOLVENTS. SUCH PRODUCTS MAY ATTACK THE PLASTICS USED IN THE CONSTRUCTION OF THE COVER.

The cover should be cleaned by means of a light solution of detergent and water applied with a soft cloth.

Dry thoroughly before using the system again.



APPENDIX A. DIGITAL TV SIGNALS

Terrestrial Digital Television (abbreviated as **TDT**) uses **COFDM** modulation (*Coded Orthogonal Frequency Division Multiplex*) which possesses the main feature of immunity to multi-path reflections.

Whereas the greater part of the power of an analogue channel is centred around the video carrier, **digital signals distribute their energy across the entire channel bandwidth**. This difference has important consequences when measuring the power of the channel.

TDT channels usually transmit 5 different TV programmes with their corresponding audio signals and other data, in this same bandwidth an analogue modulation can only transmit a single TV programme and its corresponding audio signal. Furthermore, due to the greater efficiency of digital modulation, some **20 dB** less power is needed for the same cover as an analogue signal: therefore, a digital signal with a power of **40 dB μ V** at the receiver input is equivalent to a level of **60 dB μ V** for analogue signals. On the other hand TDT receivers require a minimum **C/N** value of between **19 and 26 dB** in order to correctly decode a signal, as opposed to the **43 dB** necessary for analogue signals.

In the case of individual TDT installations without signal amplifiers, it is usually enough to test the power of the signal at the input. On the other hand, in collective TDT installations with signal amplifiers (which increase the noise level by adding the noise they generate) it is also necessary to measure the **C/N** ratio to guarantee signal quality.

Satellite band uses **QPSK** modulation (*Quaternary Phase Shift Keying*) which as with all digital TV signals uniformly spreads its energy across the entire band.

Digital channels in the satellite band are classified according to their bandwidth into *broad* or *narrow band* channels. Channel bandwidth is uniquely related to **Symbol Rate**. This parameter can take many values. Symbol Rate values of the order of 27.500 MBauds are common for broad channels and of the order of 5.000 MBauds for narrow channels. Naturally enough, the information transmitted across narrow channels is more limited.

In satellite band, relying solely on measuring power can be deceptive, as signal quality depends in great measure on the noise introduced by the LNB. It is therefore necessary to measure the C/N ratio. For the purposes of orientation and digital channels a **C/N ratio of approximately 8 dB may be sufficient for a Symbol Rate of 27.500 MBauds, or approximately 2.3 dB for a Symbol Rate of 5.000 MBauds.**

MEASURING THE POWER OF DIGITAL CHANNELS

As we have already mentioned, **digital signals distribute their energy uniformly across the entire bandwidth of the channel**, therefore measuring the power of digital channels depends on the **channel Bandwidth** or the **Symbol Rate** (the other modulation parameters do not affect this measurement).

The **MC-377** gives power measurements for digital channels under the precision specified for **terrestrial** signals of a **bandwidth of 7.607 MHz** and for **satellite** signals of a bandwidth corresponding to a **Symbol Rate of 27.500 MBauds**. **Measurements on channels made with characteristics different from these should be manually corrected as described below.**

TDT power for bandwidths other than 7.6 MHz

Terrestrial digital channels can have bandwidths of **7.607 / 6.65 / or 5.70 MHz** depending on the channelling in each country (these bandwidths correspond to a channel separation of 8, 7 and 6 MHz respectively).

Power measurements made on terrestrial digital channels with a Bandwidth other than 7.607 MHz should be corrected according to the following table.

| <u>BANDWIDTH [MHz]</u> | <u>CORRECTION [dB]</u> |
|------------------------|------------------------|
| 6.656250 | - 1 |
| 5.705357 | - 2 |

Therefore, for example, the power measurement of a digital channel of 6.65 MHz should have 1 dB subtracted from the reading obtained by the **MC-377**.

SDT power for Symbol Rate other than 27.500 MBauds

Power measurements made on satellite digital channels with a Symbol Rate other than 27.500 MBauds should be corrected according to the following table.

| <u>SYMBOL RATE [MBauds]</u> | <u>CORRECTION [dB]</u> |
|-----------------------------|------------------------|
| 30.000 | +0.5 |
| 22.000 | -1.1 |
| 20.000 | -1.3 |
| 17.180 | -2.0 |
| 9.096 | -2.6 |
| 5.632 | -3.0 |
| 5.000 | -3.1 |

Therefore, for example, the power measurement of a digital channel of 22.000 MBauds should have 1.1 dB subtracted from the reading obtained by the **MC-377**.

TABLE OF CONTENTS

| | |
|---|----|
| 1 GENERAL | 1 |
| 1.1 Description | 1 |
| 1.2 Specifications | 2 |
| 2 SAFETY RULES | 7 |
| 2.1 General | 7 |
| 2.2 Specific precautions | 8 |
| 3 INSTALLATION | 9 |
| 3.1 Operating on the electrical mains supply | 9 |
| 3.1.1 Selecting the mains operating voltage | 10 |
| 3.2 Operating on the battery | 11 |
| 3.2.1 Recharging the battery | 11 |
| 4 OPERATING INSTRUCTIONS | 13 |
| 4.1 Description of the controls and elements | 13 |
| 4.2 Using the level meter | 17 |
| 4.2.1 Start-up | 17 |
| 4.2.2 Preliminary adjustments | 17 |
| 4.2.3 Spectrum Analyser operating mode | 18 |
| 4.2.4 Monitor operating mode | 20 |
| 4.2.5 Taking measurements | 20 |
| 4.2.5.1 Measuring the level of analogue signals | 21 |
| 4.2.5.2 Measuring the power of digital channels | 23 |
| 4.2.5.3 Measuring the C/N ratio of analogue and digital signals | 25 |
| 4.2.5.3.1 Measuring the C/N ratio of analogue channels | 25 |
| 4.2.5.3.2 Measuring the C/N ratio of digital channels | 27 |
| 5 MAINTENANCE | 29 |
| 5.1 Operating recommendations | 29 |
| 5.2 Fuses replacement | 29 |
| 5.2.1 Mains fuse replacement | 29 |
| 5.2.2 Internal fuses which user cannot replace | 29 |
| 5.3 Battery replacement | 30 |
| 5.4 Cleaning recommendations | 31 |
| APPENDIX A. DIGITAL TV SIGNALS | 33 |